

# VL003 ANGLED

Tube  $\phi$ : -

Electrical element: - W

Weight: -kg

Output @50°C $\Delta$ T: - W  
- BTUs

Height:

Width:

Depth:

Face-to-face connections:

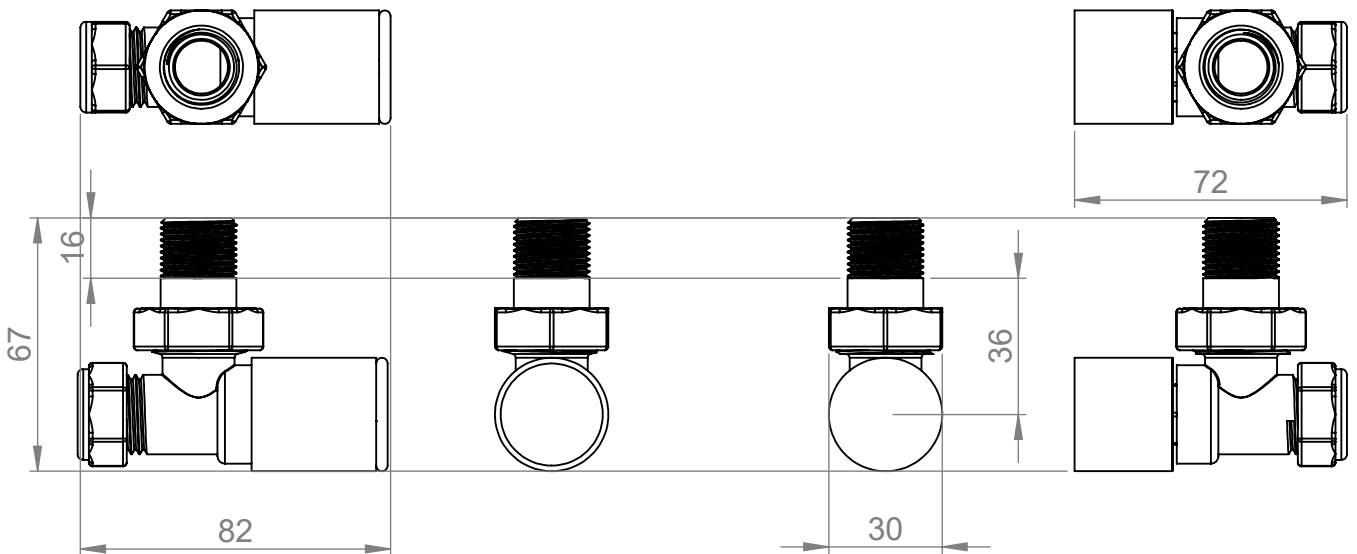
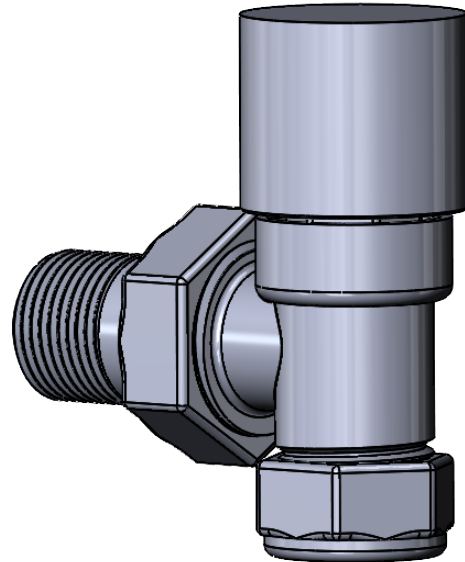
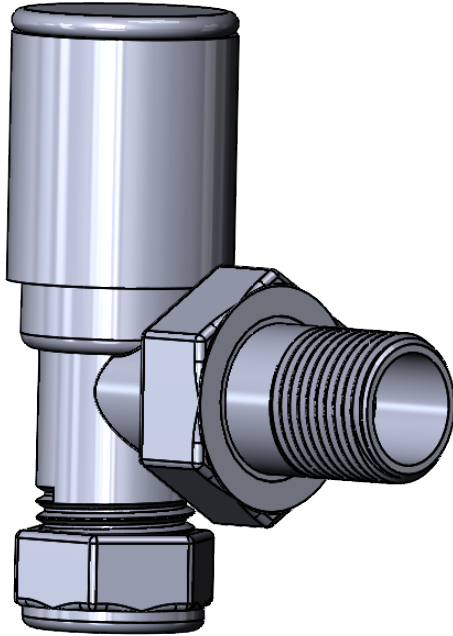

All dimensions in millimetres

Manufactured from: DZR Brass

Revision: 001

Approved by:

Drawn on: 1/24

www.vogueuk.co.uk  
01902 387000  
sales@vogueuk.co.uk

www.vogueuk.eu  
01902 387035  
exportsales@vogueuk.co.uk

www.vogueuk.com  
T: 508 887 8771 F: 508 887 8774  
info@vogueuk.com

Vogue UK Ltd. reserve the right to alter specifications without prior notice.  
ALL MEASUREMENTS ARE NOMINAL DIMENSIONS ONLY, AND ARE NOT BINDING.

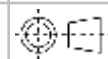

Scale 1:2