

Axis - MD062

Tube: 30 x 40 D section
& \varnothing 22mm

Electrical element: 200 W

Output @50°C Δ T: 321 W
1096 BTUs

Height: 1000mm

Width: 505mm

Depth: 90 - 105mm

Pipe centres: 455mm

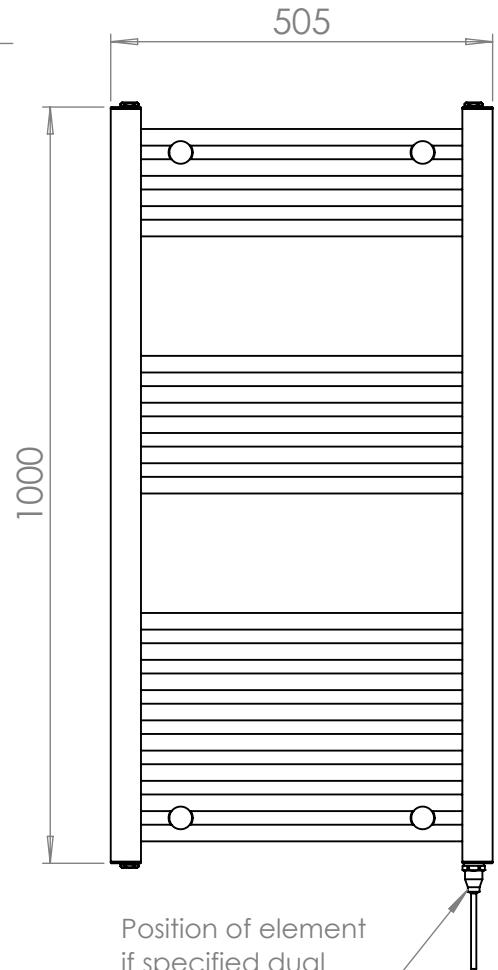
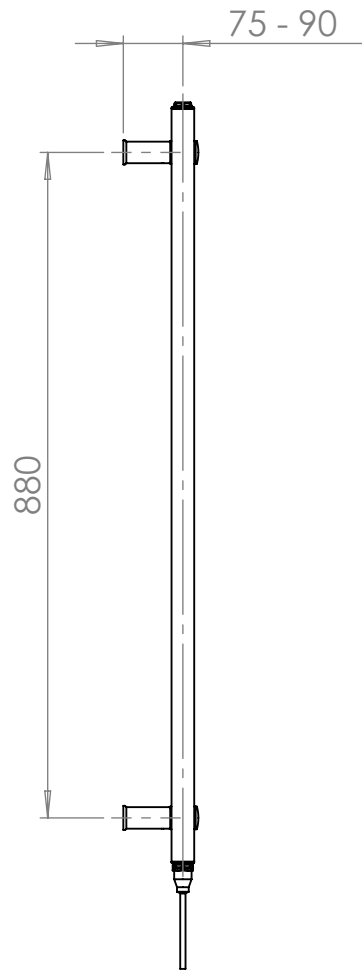
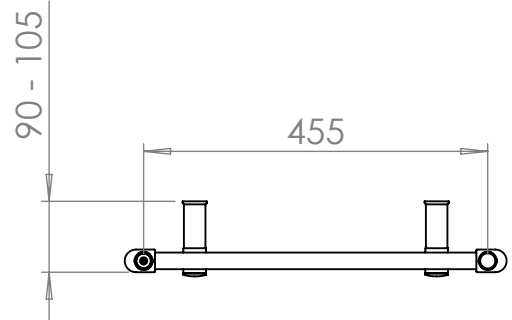
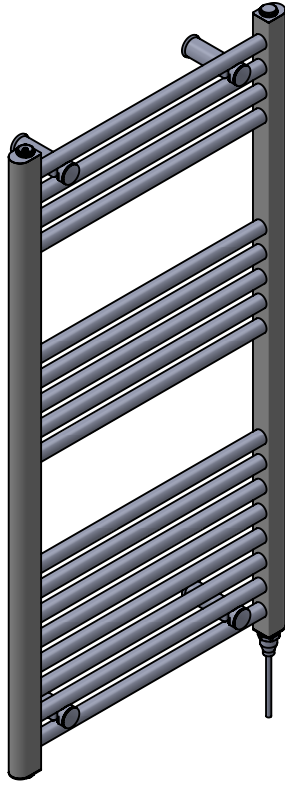

*Dual energy models require a conversion tee (AC003). Consult relevant drawing for details



All dimensions in millimetres

Manufactured from Mild Steel

Revision: 001

Approved by:

Drawn on: 01/2024

www.vogueuk.co.uk
01902 387000
sales@vogueuk.co.uk

www.vogueuk.eu
01902 387035
exportsales@vogueuk.co.uk

www.vogueuk.com
T: 508 887 8771 F: 508 887 8774
info@vogueuk.com

Vogue UK Ltd. reserve the right to alter specifications without prior notice.
ALL MEASUREMENTS ARE NOMINAL DIMENSIONS ONLY, AND ARE NOT BINDING.

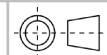

Scale 1:10